

studio

SETUP GUIDE



YOURS IS HERE

studio

SETUP GUIDE

Model PP40L

Notes, Cautions, and Warnings

 **NOTE:** A NOTE indicates important information that helps you make better use of your computer.

 **CAUTION:** A CAUTION indicates either potential damage to hardware or loss of data and tells you how to avoid the problem.

 **WARNING:** A WARNING indicates a potential for property damage, personal injury, or death.

If you purchased a Dell™ n Series computer, any references in this document to Microsoft® Windows® operating systems are not applicable.

Information in this document is subject to change without notice.

© 2009 Dell Inc. All rights reserved.

Reproduction of these materials in any manner whatsoever without the written permission of Dell Inc. is strictly forbidden.

Trademarks used in this text: *Dell*, the *DELL* logo, *YOURS IS HERE*, and *DellConnect* are trademarks of Dell Inc.; *Intel*, *Pentium*, and *Celeron* are registered trademarks and *Core* is a trademark of Intel Corporation in the United States and/or other countries; *Microsoft*, *Windows*, *Windows Vista*, and *Windows Vista* start button logo are either trademarks or registered trademarks of Microsoft Corporation in the United States and/or other countries; *Bluetooth* is a registered trademark owned by Bluetooth SIG, Inc. and is used by Dell under license.

Other trademarks and trade names may be used in this document to refer to either the entities claiming the marks and names or their products. Dell Inc. disclaims any proprietary interest in trademarks and trade names other than its own.

February 2009

P/N C547M

Rev. A00

Contents

Setting Up Your Studio Laptop	5	Display Features	26
Before Setting Up Your Computer	5	Removing and Replacing the	
Connect the AC Adapter	6	Battery	27
Connect the Network Cable (Optional)	7	Software Features	28
Press the Power Button	7	Solving Problems	31
Microsoft® Windows Vista® Setup	8	Beep Codes	31
Installing the SIM (Optional)	8	Network Problems	32
Enable or Disable Wireless (Optional)	10	Power Problems	33
Connect to the Internet (Optional)	11	Memory Problems	34
Using Your Studio Laptop	14	Lockups and Software Problems	35
Right Side Features	14	Using Support Tools	38
Left Side Features	18	Dell Support Center	38
Computer Base and Keyboard		System Messages	39
Features	20	Hardware Troubleshooter	41
Touch Pad Gestures	22	Dell Diagnostics	41
Media Controls	24		

Contents

Restoring Your Operating System	44	Appendix	66
System Restore	44	Macrovision Product Notice.....	66
Dell Factory Image Restore	45	Index	67
Operating System Reinstallation	47		
Getting Help	49		
Technical Support and Customer Service	50		
DellConnect™	50		
Online Services	51		
Automated Order-Status Service.....	52		
Product Information.....	52		
Returning Items for Repair Under Warranty or for Credit.....	53		
Before You Call.....	54		
Contacting Dell.....	55		
Finding More Information and Resources	56		
Specifications	58		

Setting Up Your Studio Laptop

This section provides information about setting up your Studio 14z laptop and connecting peripherals.

Before Setting Up Your Computer

When positioning your computer, ensure that you allow easy access to a power source, adequate ventilation, and a level surface to place your computer.

Restricting airflow around your Studio laptop may cause it to overheat. To prevent overheating ensure that you leave at least 10.2 cm (4 inches) at the back of the computer and a minimum of 5.1 cm (2 inches) on all other sides. You should never place your computer in an enclosed space, such as a cabinet or drawer when it is powered on.

 **WARNING:** Do not block, push objects into, or allow dust to accumulate in the air vents. Do not store your Dell™ computer in a low-airflow environment, such as a closed briefcase, while it is powered on. Restricting the airflow can damage the computer or cause a fire. The computer turns on the fan when the computer gets hot. Fan noise is normal and does not indicate a problem with the fan or the computer.

 **CAUTION:** Placing or stacking heavy or sharp objects on the computer may result in permanent damage to the computer.

Connect the AC Adapter

Connect the AC adapter to the computer and then plug it into an electrical outlet or surge protector.

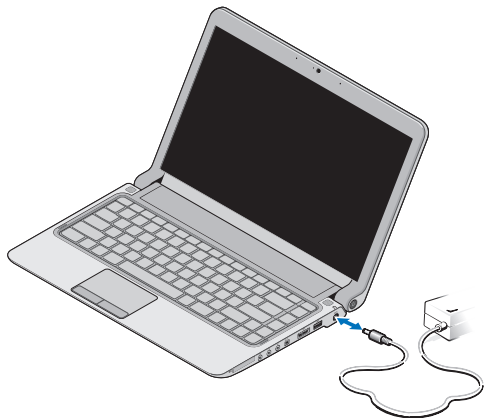

NOTE: Use only Dell AC adapter family PA-2E or PA-12 with your computer.

WARNING: The AC adapter works with electrical outlets worldwide. However, power connectors and power strips vary among countries. Using an incompatible cable or improperly connecting the cable to a power strip or electrical outlet may cause fire or permanent damage to your computer.

Connect the Network Cable (Optional)

To use a wired network connection, connect the network cable.

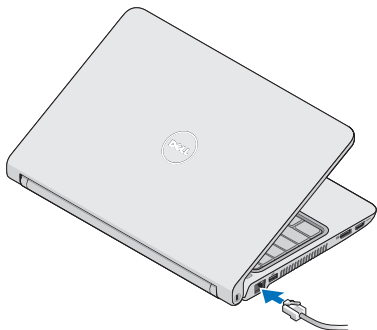

Press the Power Button

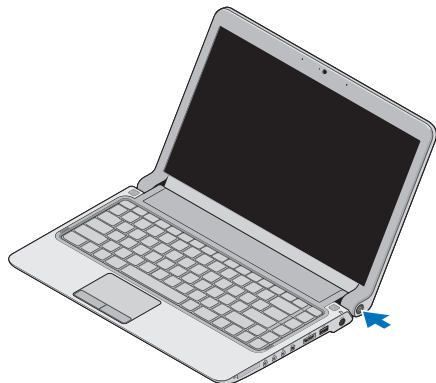

Microsoft® Windows Vista® Setup

Your Dell computer is preconfigured with Windows Vista. To set up Windows Vista for the first time, follow the instructions on the screen. These steps are mandatory and may take up to 15 minutes to complete. The screens will take you through several procedures including accepting license agreements, setting preferences, and setting up an Internet connection.

 **CAUTION: Do not interrupt the operating system's setup process. Doing so may render your computer unusable and you will need to reinstall the operating system.**

Installing the SIM (Optional)

Subscriber Identity Module (SIM) cards identify users uniquely through an International Mobile Subscriber Identity.

 **NOTE:** Only GSM (HSDPA) type cards need a SIM. EVDO cards do not use a SIM.

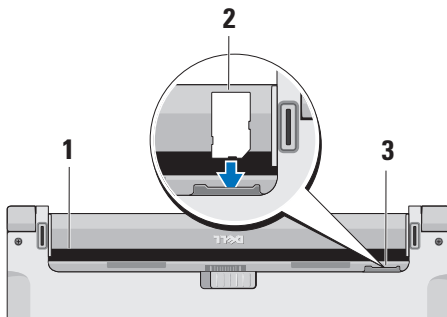

- 1 Battery bay
- 2 SIM card
- 3 SIM card slot

To insert the SIM:

1. Turn off your computer.
2. Remove the battery, see “Removing and Replacing the Battery” on page 27.
3. In the battery bay, slide the SIM into the SIM card slot.

Enable or Disable Wireless (Optional)

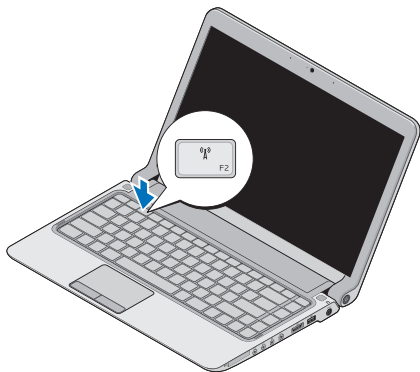

To turn on wireless, with the computer turned on:

1. Press <Fn><F2> or press the  key on the keyboard.

The Wireless icon appears at the bottom right of the screen

2. Select one of the following:

- **Enable Bluetooth**
- **Enable Wireless LAN**
- **Enable Wireless WAN/GPS**

3. Click **OK**.

To turn off wireless, press <Fn><F2> or press the  key on the keyboard.

Connect to the Internet (Optional)

 **NOTE:** ISPs and ISP offerings vary by country.

To connect to the Internet, you need an external modem or network connection and an Internet service provider (ISP).

 **NOTE:** If an external USB modem or WLAN adapter is not a part of your original order, you can purchase one from the Dell website at www.dell.com.

Setting Up a Wired Connection

- If you are using a dial-up connection, connect the telephone line to the external USB modem (optional) and to the telephone wall connector before you set up your Internet connection.
- If you are using a DSL or cable/satellite modem connection, contact your ISP or cellular telephone service for setup instructions

To complete setting up your wired internet connection, follow the instructions in “Setting Up Your Internet Connection” on page 12.

Setting Up a Wireless Connection

 **NOTE:** To set up your wireless router, see the documentation that shipped with your router.

Before you can use your wireless Internet connection, you need to connect to your wireless router.

To setup your connection to a wireless router:

1. Save and close any open files, and exit any open programs.
2. Click **Start**  → **Connect To**.
3. Follow the instructions on the screen to complete the setup.

Setting Up Your Studio Laptop

Setting Up Your Internet Connection

To set up an Internet connection with a provided ISP desktop shortcut:

1. Save and close any open files, and exit any open programs.
2. Double-click the ISP icon on the Microsoft Windows® desktop.
3. Follow the instructions on the screen to complete the setup.

If you do not have an ISP icon on your desktop or if you want to set up an Internet connection with a different ISP, perform the steps in the following section.

 **NOTE:** If you cannot connect to the Internet but have successfully connected in the past, the ISP might have a service outage. Contact your ISP to check the service status, or try connecting again later.

 **NOTE:** Have your ISP information ready. If you do not have an ISP, the **Connect to the Internet** wizard can help you get one.

1. Save and close any open files, and exit any open programs.
2. Click **Start**  → **Control Panel**.
3. Under **Network and Internet**, click **Connect to the Internet**.

The **Connect to the Internet** window appears.

4. Select either **Broadband (PPPoE)** or **Dial-up**, depending on how you want to connect:
 - Choose **Broadband** if you will use a DSL, satellite modem, cable TV modem, or wireless technology connection.
 - Choose **Dial-up** if you will use an optional USB dial-up modem or ISDN.

 **NOTE:** If you do not know which type of connection to select, contact your ISP.

5. Follow the instructions on the screen and use the setup information provided by your ISP to complete the setup.

Using Your Studio Laptop

Your Studio 14z laptop has indicators and buttons that provide information and enable you to perform common tasks. The connectors on your computer provide the option of attaching additional devices.

Right Side Features

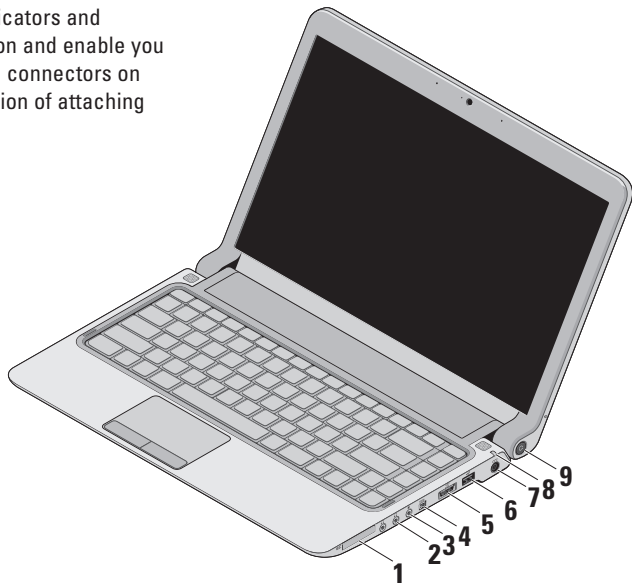

1 ExpressCard slot/8-in-1 Media Card





Reader adapter – Provides support for additional memory, wired and wireless communications, multimedia, and security features. Supports 34 mm ExpressCards. If you have ordered an 8-in-1 media card adapter, it is installed in the slot. If not, the computer ships with a plastic blank installed in the slot.

The 8-in-1 memory card reader adapter reads the following digital media memory cards:

- Secure Digital (SD) memory card
- MultiMediaCard (MMC)
- MMC+
- Memory Stick
- Memory Stick PRO
- xD-Picture Card

- Hi Speed-SD
- Hi Density-SD

 **NOTE:** The plastic blank or media card adapter installed in the ExpressCard slot protects unused slots from dust and other particles. Save the blank or media card adapter for use when no ExpressCard is installed in the slot. Blanks from other computers may not fit your computer.

-  **2 Audio out/Headphone connectors (2)** – Connects one or two pairs of headphones, or sends audio to a powered speaker or sound system. The audio signal is the same for both connectors.
-  **3 Audio in/Microphone connector** – Connects to a microphone or inputs signal for use with audio programs.
-  **4 IEEE 1394 connector** – Connects to high-speed serial multimedia devices, such as digital video cameras.
-  **5 eSATA/USB combo connector with USB PowerShare** – Connects to eSATA compatible storage devices (such as external hard disk drives or optical drives) or USB devices (such as a mouse, keyboard, printer, external drive, or MP3 player).

The USB Powershare feature allows you to charge USB devices when the computer is powered on/off or in sleep state.

 **NOTE:** Certain USB devices may not charge when the computer is powered off or in sleep state. In such cases, turn on the computer to charge the device.

 **NOTE:** If you turn off your computer while charging an USB device, the device will stop charging. To continue charging, disconnect the USB device and connect it again.

 **NOTE:** The USB PowerShare is automatically shut off when only 10% of the total battery life remains.

-  **6 USB 2.0 connector** – Connects to USB devices, such as a mouse, keyboard, printer, external drive, or MP3 player.

7  **AC adapter connector** – Connects to the AC adapter to power the computer and charge the battery.

8  **Battery status light** – Turns on steadily or blinks to indicate the battery charge status. The light indicates the following states when the computer is powered by *the battery*:

- No light – The battery is adequately charged.
- Solid amber – The battery charge is low.

the AC adapter:

- Solid amber – The battery is charging.
- Solid white – The battery is almost fully charged.
- Off – The battery is fully charged.

9  **Power button and light** – Turns the computer on or off when pressed. The light in the button indicates the following power state:

- Solid white – The computer is on.
- Blinking white – The computer is in standby mode.
- Off – The computer is off.

Left Side Features

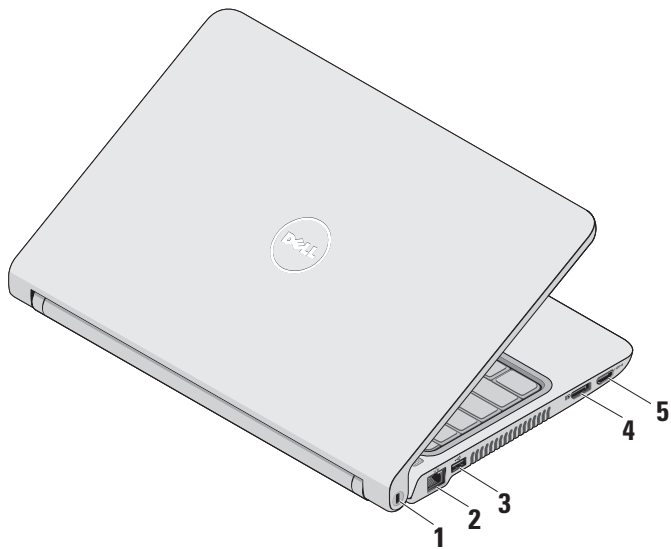



- 1 **Security cable slot** – Attaches a commercially available antitheft device to the computer.

 **NOTE:** Before you buy an antitheft device, ensure that it works with the security cable slot on your computer.

- 2  **Network connector** – Connects your computer to a network or a broadband device if you are using a wired network.

- 3  **USB 2.0 connector** – Connects to USB devices, such as a mouse, keyboard, printer, external drive, or MP3 player.

- 4  **DisplayPort connector** – Digital interface standard connector that supports external DisplayPort monitors and projectors.

- 5  **HDMI connector** – Connects to a TV for both 5.1 audio and video signals.

 **NOTE:** When used with a monitor, only the video signal is read.

Computer Base and Keyboard Features

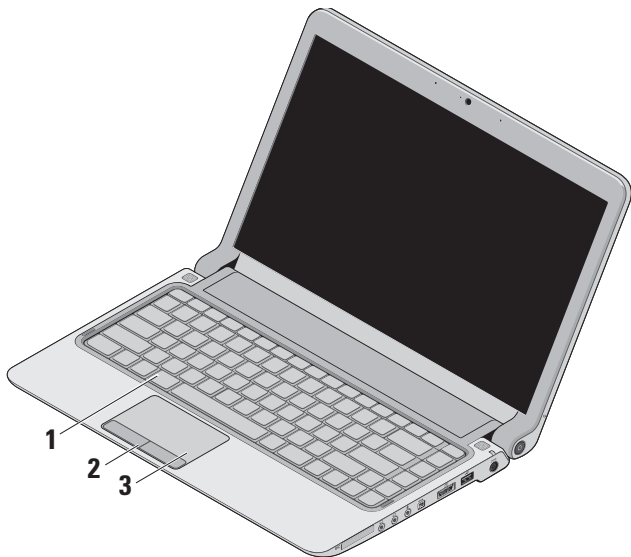

1 **Keyboard/Backlit keyboard (optional)** –

If you have purchased the optional backlit keyboard, the F6 key has the backlit keyboard icon  on it. The optional backlit keyboard provides visibility in dark environments by illuminating all symbols on the keys.

For more information on using the keyboard, see the *Dell Technology Guide*.



Backlit keyboard brightness settings

– Press <Fn><F6> key to toggle the three lighting states (in the given order):

- a. half keyboard brightness
- b. full keyboard brightness
- c. no lighting

2 **Touch pad buttons** – Provide left- and right-click functions like those on a mouse.

3 **Touch pad** – Provides the functionality of a mouse to move the cursor, drag or move selected items, and left-click by tapping the surface.

It supports scroll, zoom, and rotate features. To change the settings, double-click the **Dell Touch pad** icon in the notification area of your desktop.

Touch Pad Gestures

Scroll

Allows you to scroll through content. The scroll feature includes:

Traditional Scroll – Allows you to scroll up and down, or right and left.

To scroll up and down:



Move a finger up or down in the vertical scroll zone (extreme right of the touch pad) to scroll up or down on the active window.

To scroll right and left:

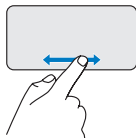

Move a finger right or left in the horizontal scroll zone (extreme bottom of the touch pad) to scroll right or left on the active window.

Circular Scroll – Allows you to scroll up and down, or right and left.

To scroll up and down:

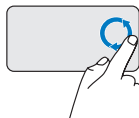

Move a finger in the vertical scroll zone (extreme right of the touch pad), in a clockwise circular motion to scroll up or counterclockwise circular motion to scroll down.

To scroll right and left:

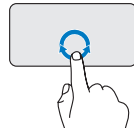

Move a finger in the horizontal scroll zone (extreme bottom of the touch pad), in a clockwise circular motion to scroll right or counterclockwise circular motion to scroll left.

Zoom

Allows you to increase or decrease the magnification of the screen content. The zoom feature includes:

One finger zoom – Allows you to zoom in or out.

To zoom in:

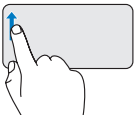

Move a finger up in the zoom zone (extreme left of the touch pad) to zoom in.

To zoom out:

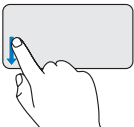

Move a finger down in the zoom zone (extreme left of the touch pad) to zoom out.

Media Controls

The media control keys are located on the keyboard control media playback.

To use the media controls, press the required key.

You can configure the media control keys using the **Function Key Behavior** in the **System Setup** utility. The options in the Function Key Behavior setting are:







Multimedia Key First - This is the default setting. Pressing any media control key performs the associated multimedia action. For function key action, press <Fn> + the required function key.

Function Key First - Pressing any function key performs the associated function. For multimedia action, press <Fn> + the required media control key.



NOTE: The Multimedia Key First option is active only in the operating system.



-  Mute the sound
-  Turn down the volume
-  Turn up the volume
-  Play the previous track or chapter by pressing the key once
Fast rewind by pressing and holding the key
-  Play or pause
-  Play the next track or chapter by pressing the key once
Fast forward by pressing and holding the key
-  Eject the disc from optional USB/eSATA optical drive.

Display Features

The display panel holds a camera and accompanying dual microphones.

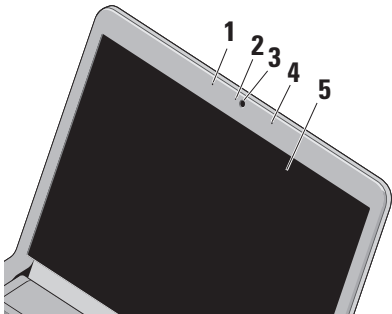

1 Left digital array microphone – Combines with the right digital array microphone to provide high quality sound for video chatting and voice recording.

2 Camera activity light – Indicates if the camera is on or off.

3 Camera – Built-in camera for video capture, conferencing, and chat.

4 Right digital array microphone – Combines with the left digital array microphone to provide high quality sound for video chatting and voice recording.

5 Display – Your display can vary based on selections you made when purchasing your computer. For more information about displays, see the *Dell Technology Guide*.

Removing and Replacing the Battery

⚠ WARNING: Using an incompatible battery may increase the risk of fire or explosion. This computer should only use a battery purchased from Dell. Do not use batteries from other computers.

⚠ WARNING: Before removing the battery, shut down the computer, and remove external cables (including the AC adapter).

To remove the battery:

1. Shut down the computer and turn it over.
2. Slide the battery release latch to the side.
3. Slide the battery out.

To replace the battery, slide it into the bay until it clicks into place.

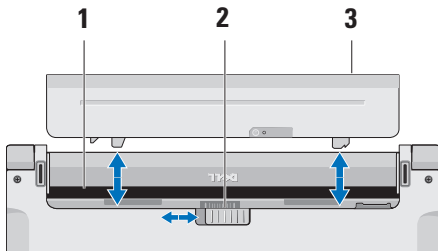

- 1 Battery bay
- 2 Battery release latch
- 3 Battery

Software Features

 **NOTE:** For more information about the features described in this section, see the *Dell Technology Guide* on your hard drive or on the Dell Support website at support.dell.com.

FastAccess facial recognition

Your computer may have the FastAccess facial recognition feature. This feature helps keep your Dell computer secure by learning the unique appearance of your face and uses this to verify your identity to automatically supply login information when you would normally enter this information yourself (such as for logging into a Windows account or into secure websites). For more information, click

Start  → **Programs** → **FastAccess**

Productivity and Communication

You can use your computer to create presentations, brochures, greeting cards, fliers, and spreadsheets. You can also edit and view digital photographs and images. Check your purchase order for software installed on your computer.

After connecting to the Internet, you can access websites, setup an e-mail account, upload and download files, and so on.

Entertainment and Multimedia

You can use your computer to watch videos, play games, create your own CDs/DVDs, listen to music and internet radio stations.

 **NOTE:** Your computer does not have an internal optical drive. Use an external optical drive or any external storage device for the procedures that involve discs.

You can download or copy pictures and video files from portable devices, such as digital cameras and cell phones. Optional software applications enable you to organize and create music and video files that can be recorded to disc, saved on portable products such as MP3 players and handheld entertainment devices, or played and viewed directly on connected TVs, projectors, and home theater equipment.

Customizing the Desktop

You can customize your desktop to change the appearance, resolution, wallpaper, screensaver, and so on by accessing the **Personalize appearance and sounds** window.

To access the display properties window:

1. Right-click an open area of the desktop.
2. Click **Personalize**, to open the **Personalize appearance and sounds** window and learn more about your customization options.

Customizing Your Energy Settings

You can use the power options in your operating system to configure the power settings on your computer. Microsoft® Windows Vista® installed with your Dell computer provides three default options:

- **Dell Recommended** — This power option offer full performance when you need it and saves power during periods of inactivity.
- **Power saver** — This power option saves power on your computer by reducing system performance to maximize the life of the computer and by reducing the amount of energy consumed by your computer over its lifetime.
- **High performance** — This power option provides the highest level of system performance on your computer by adapting processor speed to your activity and by maximizing system performance.

Backing Up Your Data

It is recommended that you periodically back up files and folders on your computer. To back up files:

1. Click **Start**  → **Control Panel** → **System and Maintenance** → **Welcome Center** → **Transfer files and settings**.
2. Click **Back up files** or **Back up computer**.
3. Click **Continue** on the **User Account Control** window and follow the instructions in the **Back up Files** wizard.

Solving Problems

This section provides troubleshooting information for your computer. If you cannot solve your problem using the following guidelines, see “Using Support Tools” on page 38 or “Contacting Dell” on page 55.



WARNING: Only trained service personnel should remove the computer cover. See the *Service Manual* on the Dell Support website at support.dell.com for advanced service and troubleshooting instructions.

Beep Codes

Your computer might emit a series of beeps during start-up if the monitor cannot display errors or problems. The following repetitive beep codes help you troubleshoot problems with your computer.



NOTE: To replace parts see the *Service Manual* on the Dell Support website at support.dell.com.

One beep — *BIOS ROM checksum failure.
Possible motherboard failure*

Contact Dell (see “Contacting Dell” on page 55).

Two beeps — *No RAM Detected*

- Remove the memory modules, reinstall one module and restart the computer. If the computer starts normally, reinstall an additional module. Continue until you have identified a faulty module or reinstalled all modules without an error.

Solving Problems

- If available, install memory modules of the same type in your computer.
- If the problem persists, contact Dell (see “Contacting Dell” on page 55).

Three beeps — *Possible motherboard failure*

Contact Dell (see “Contacting Dell” on page 55).

Four beeps — *RAM Read/Write failure*

- Ensure that no special memory module/memory connector placement requirements exist (see the *Service Manual* on the Dell Support website at support.dell.com).
- Verify that the memory modules that you are installing are compatible with your computer.
- If the problem persists, contact Dell (see “Contacting Dell” on page 55).

Five beeps — *Real Time Clock Failure*

Replace the battery.

Network Problems

Wireless Connections

If the wireless network connection is lost —

The wireless router is offline or wireless has been disabled on the computer.

- Check your wireless router to ensure it is powered on and connected to your data source (cable modem or network hub).
- Interference may be blocking or interrupting your wireless connection. Try moving the computer closer to your wireless router.
- Re-establish your connection to the wireless router:
 - a. Save and close any open files, and exit any open programs.
 - b. Click **Start**  → **Connect To**.
 - c. Follow the instructions on the screen to complete the setup.

Wired Connections

If the network connection is lost — The cable is loose or damaged.

- Check the cable to ensure it is plugged in and not damaged.

The link integrity light on the integrated network connector lets you verify that your connection is working and provides information on the status:

- Green — A good connection exists between a 10-Mbps network and the computer.
- Orange — A good connection exists between a 100-Mbps network and the computer.
- Off — The computer is not detecting a physical connection to the network.

 **NOTE:** The link integrity light on the network connector is only for the wired cable connection. The link integrity light does not provide status for wireless connections.

Power Problems

If the power light is off — The computer is either turned off or is not receiving power.

- Reseat the power cable into both the power connector on the computer and the electrical outlet.
- If the computer is plugged into a power strip, ensure that the power strip is plugged into an electrical outlet and that the power strip is turned on. Also bypass power protection devices, power strips, and power extension cables to verify that the computer turns on properly.
- Ensure that the electrical outlet is working by testing it with another device, such as a lamp.
- Check the AC adapter cable connections. If the AC adapter has a light, ensure that the light on the AC adapter is on.

Solving Problems

If the power light is solid white and the computer is not responding — The display may not be responding. Press the power button until the computer turns off and then turn it back on.

If the power light is blinking white — The computer is in standby mode. Move the pointer using the connected mouse or press the power button to resume normal operation.

If you encounter interference that hinders reception on your computer — An unwanted signal is creating interference by interrupting or blocking other signals. Some possible causes of interference are:

- Power, keyboard, and mouse extension cables.
- Too many devices connected to a power strip.
- Multiple power strips connected to the same electrical outlet.

Memory Problems

If you receive an insufficient memory message —

- Save and close any open files and exit any open programs you are not using to see if that resolves the problem.
- See the software documentation for minimum memory requirements. If necessary, install additional memory (see the *Service Manual* on the Dell Support website at support.dell.com).
- Reseat the memory modules (see the *Service Manual* on the Dell Support website at support.dell.com) to ensure that your computer is successfully communicating with the memory.

If you experience other memory problems —

- Ensure that you are following the memory installation guidelines (see the *Service Manual* on the Dell Support website at support.dell.com).
- Check if the memory module is compatible with your computer. Your computer supports DDR3 memory. For more information about the type of memory supported by your computer, see “Specifications” on page 58.
- Run the Dell Diagnostics (see “Dell Diagnostics” on page 41).
- Reseat the memory modules (see the *Service Manual* on the Dell Support website at support.dell.com) to ensure that your computer is successfully communicating with the memory.

Lockups and Software Problems

If the computer does not start up — Ensure that the power cable is firmly connected to the computer and to the electrical outlet.

If a program stops responding or a solid blue screen appears — End the program:

1. Press <Ctrl><Shift><Esc> simultaneously.
2. Click **Applications**.
3. Click the program that is no longer responding
4. Click **End Task**.

If a program crashes repeatedly — Check the software documentation. If necessary, uninstall and then reinstall the program.

 **NOTE:** Software usually includes installation instructions in its documentation or on the CD.

Solving Problems

 **NOTE:** Your computer does not have an internal optical drive. Use an external optical drive or any external storage device for the procedures that involve discs.

If the computer stops responding or a solid blue screen appears —

 **WARNING:** You might lose data if you are unable to perform an operating system shutdown.

If you are unable to get a response by pressing a key on your keyboard or moving your mouse, press the power button for at least 8 to 10 seconds until the computer turns off and then restart your computer.

If a program is designed for an earlier Microsoft® Windows® operating system —

Run the Program Compatibility Wizard. The Program Compatibility Wizard configures a program so that it runs in an environment similar to non-Windows Vista operating system environments.

1. Click **Start**  → **Control Panel** → **Programs** → **Use an older program with this version of Windows.**

2. In the welcome screen, click **Next**.

3. Follow the instructions on the screen.

If you have other software problems —

- Back up your files immediately.
- Use a virus-scanning program to check the hard drive or CDs.
- Save and close any open files or programs and shut down your computer through the **Start**  menu.
- Check the software documentation or contact the software manufacturer for troubleshooting information:
 - Ensure that the program is compatible with the operating system installed on your computer.

- Ensure that your computer meets the minimum hardware requirements needed to run the software. See the software documentation for information.
- Ensure that the program is installed and configured properly.
- Verify that the device drivers do not conflict with the program.
- If necessary, uninstall and then reinstall the program.

Using Support Tools

Dell Support Center

The Dell Support Center helps you find the service, support, and system-specific information you need. For more information about Dell Support Center and available support tools, click the **Services** tab at support.dell.com.



Click the  icon in the taskbar to run the application. The home page provides links to access:

- Self Help (Troubleshooting, Security, System Performance, Network/Internet, Backup/Recovery, and Windows Vista)
- Alerts (technical support alerts relevant to your computer)
- Assistance from Dell (Technical Support with DellConnect™, Customer Service, Training and Tutorials, How-To Help with Dell on Call, and Online Scan with PC CheckUp)

- About Your System (System Documentation, Warranty Information, System Information, Upgrades & Accessories)

The top of the Dell Support Center home page displays your system's model number along with its service tag and express service code.

For more information about the Dell Support Center, see the *Dell Technology Guide* on your hard drive or on the Dell Support website at support.dell.com.

System Messages

If your computer has an issue or error, it may display a System Message that will help you identify the cause and action needed to resolve the issue.

 **NOTE:** If the message you received is not listed in the following examples, see the documentation for either the operating system or the program that was running when the message appeared. Alternatively you could see the *Dell Technology Guide* on your hard disk or on the Dell Support website at support.dell.com or see “Contacting Dell” on page 55 for assistance.

Alert! Previous attempts at booting this system have failed at checkpoint [nnnn]. For help in resolving this problem, please note this checkpoint and contact Dell Technical Support — The computer failed to complete the boot routine three consecutive times for the same error (see “Contacting Dell” on page 55 for assistance).

CMOS checksum error — Possible motherboard failure or RTC battery low. Replace the battery (see the *Service Manual* on the Dell Support website at support.dell.com or see “Contacting Dell” on page 55 for assistance).

CPU fan failure — CPU fan has failed. Replace the CPU fan (see the *Service Manual* on the Dell Support website at support.dell.com).

Hard-disk drive failure — Possible hard disk drive failure during POST (see “Contacting Dell” on page 55 for assistance).

Hard-disk drive read failure — Possible hard disk drive failure during HDD boot test (see “Contacting Dell” on page 55 for assistance).

Keyboard failure — Keyboard failure or loose cable.

To replace the keyboard, see the *Service Manual* on the Dell Support website at support.dell.com.

Using Support Tools

No boot device available — No bootable partition on hard disk drive, the hard disk drive cable is loose, or no bootable device exists.

- If the hard drive is your boot device, ensure that the cables are connected and that the drive is installed properly and partitioned as a boot device.
- Enter system setup and ensure that the boot sequence information is correct (see the *Dell Technology Guide* on the Dell Support website at support.dell.com).

No timer tick interrupt — A chip on the system board might be malfunctioning or motherboard failure (see “Contacting Dell” on page 55 for assistance).

USB over current error — Disconnect the USB device. Your USB device needs more power for it to function properly. Use an external power source to connect the USB device, or if your device has two USB cables, connect both of them.

CAUTION - Hard Drive SELF MONITORING SYSTEM has reported that a parameter has exceeded its normal operating range. Dell recommends that you back up your data regularly. A parameter out of range may or may not indicate a potential hard drive problem — S.M.A.R.T error, possible hard disk drive failure (see “Contacting Dell” on page 55 for assistance).

Hardware Troubleshooter

If a device is either not detected during the operating system setup or is detected but incorrectly configured, you can use the **Hardware Troubleshooter** to resolve the incompatibility.

To start the Hardware Troubleshooter:

1. Click **Start**  → **Help and Support**.
2. Type `hardware troubleshooter` in the search field and press <Enter> to start the search.
3. In the search results, select the option that best describes the problem and follow the remaining troubleshooting steps.

Dell Diagnostics

If you experience a problem with your computer, perform the checks in “Lockups and Software Problems” on page 35 and run the Dell Diagnostics before you contact Dell for technical assistance.

 **CAUTION:** Dell Diagnostics works only on Dell computers.

 **NOTE:** The *Drivers and Utilities* disc is optional and may not ship with your computer.

See the *Dell Technology Guide* to review your computer’s configuration information, and ensure that the device that you want to test displays in the system setup program and is active.

Start the Dell Diagnostics from your hard drive or from the *Drivers and Utilities* disc.

Starting Dell Diagnostics From Your Hard Drive

The Dell Diagnostics is located on a hidden diagnostic utility partition on your hard drive.

 **NOTE:** If your computer cannot display a screen image, see “Contacting Dell” on page 55.

1. Ensure that the computer is connected to an electrical outlet that is known to be working properly.
2. Turn on (or restart) your computer.
3. When the DELL™ logo appears, press <F12> immediately. Select **Diagnostics** from the boot menu and press <Enter>.

 **NOTE:** If you wait too long and the operating system logo appears, continue to wait until you see the Microsoft® Windows® desktop; then, shut down your computer and try again.

 **NOTE:** If you see a message stating that no diagnostics utility partition has been found, run the Dell Diagnostics from the *Drivers and Utilities* disc.

4. Press any key to start the Dell Diagnostics from the diagnostics utility partition on your hard drive.

Starting Dell Diagnostics From the Drivers and Utilities Disc

 **NOTE:** Your computer does not have an internal optical drive. Use an external optical drive or any external storage device for the procedures that involve discs

1. Insert the *Drivers and Utilities* disc.
2. Shut down and restart the computer. When the DELL logo appears, press <F12> immediately.

 **NOTE:** If you wait too long and the operating system logo appears, continue to wait until you see the Microsoft® Windows® desktop; then, shut down your computer and try again.

-  **NOTE:** The next steps change the boot sequence for one time only. On the next start-up, the computer boots according to the devices specified in the system setup program.
3. When the boot device list appears, highlight **CD/DVD/CD-RW** and press <Enter>.
 4. Select the **Boot from CD-ROM** option from the menu that appears and press <Enter>.
 5. Type 1 to start the CD menu and press <Enter> to proceed.
 6. Select **Run the 32 Bit Dell Diagnostics** from the numbered list. If multiple versions are listed, select the version appropriate for your computer.
 7. When the Dell Diagnostics **Main Menu** appears, select the test you want to run.

Restoring Your Operating System

You can restore your operating system in the following ways:

- System Restore returns your computer to an earlier operating state without affecting data files. Use System Restore as the first solution for restoring your operating system and preserving data files.
- Dell Factory Image Restore returns your hard drive to the operating state it was in when you purchased the computer. This procedure permanently deletes all data on the hard drive and removes any programs installed after you received the computer. Use Dell Factory Image Restore only if System Restore did not resolve your operating system problem.
- If you received an Operating System disc with your computer, you can use it to restore your operating system. However, using the

Operating System disc also deletes all data on the hard drive. Use the disc only if System Restore did not resolve your operating system problem.

 **NOTE:** Your computer does not have an internal optical drive. Use an external optical drive or any external storage device for the procedures that involve discs.



System Restore

The Windows operating systems provide a System Restore option which allows you to return your computer to an earlier operating state (without affecting data files) if changes to the hardware, software, or other system settings have left the computer in an undesirable operating state. Any changes that System Restore makes to your computer are completely reversible.

 **CAUTION:** Make regular backups of your data files. System Restore does not monitor your data files or recover them.

 **NOTE:** The procedures in this document were written for the Windows default view, so they may not apply if you set your Dell™ computer to the Windows Classic view.

Starting System Restore

1. Click **Start** .
 2. In the **Start Search** box, type `System Restore` and press <Enter>.
-  **NOTE:** The **User Account Control** window may appear. If you are an administrator on the computer, click **Continue**; otherwise, contact your administrator to continue the desired action.
3. Click **Next** and follow the remaining prompts on the screen.

In the event that System Restore did not resolve the issue, you may undo the last system restore.

Undoing the Last System Restore

 **NOTE:** Before you undo the last system restore, save and close all open files and exit any open programs. Do not alter, open, or delete any files or programs until the system restoration is complete.

1. Click **Start** .
2. In the **Start Search** box, type `System Restore` and press <Enter>.
3. Click **Undo my last restoration** and click **Next**.

Dell Factory Image Restore

 **WARNING:** Using Dell Factory Image Restore permanently deletes all data on the hard drive and removes any programs or drivers installed after you received your computer. If possible, back up the data before using these options. Use Dell Factory Image Restore only if System Restore did not resolve your operating system problem.

Restoring Your Operating System

 **NOTE:** Dell Factory Image Restore may not be available in certain countries or on certain computers.

Use Dell Factory Image Restore only as the last method to restore your operating system. This option restores your hard drive to the operating state it was in when you purchased the computer. Any programs or files added since you received your computer—including data files—are permanently deleted from the hard drive. Data files include documents, spreadsheets, e-mail messages, digital photos, music files, and so on. If possible, back up all data before using Dell Factory Image Restore.

Dell Factory Image Restore

1. Turn on the computer. When the Dell logo appears, press <F8> several times to access the **Vista Advanced Boot Options** window.

 **NOTE:** If you wait too long and the operating system logo appears, continue to wait until you see the Microsoft® Windows® desktop; then, shut down your computer and try again.

2. Select **Repair Your Computer**.
 3. The **System Recovery Options** window appears.
 4. Select a keyboard layout and click **Next**.
 5. To access the recovery options, log on as a local user. To access the command prompt, type `administrator` in the **User name** field, then click **OK**.
 6. Click **Dell Factory Image Restore**. The **Dell Factory Image Restore** welcome screen appears.
-  **NOTE:** Depending upon your configuration, you may need to select **Dell Factory Tools**, then **Dell Factory Image Restore**.

7. Click **Next**. The **Confirm Data Deletion** screen appears.

 **NOTE:** If you do not want to proceed with Factory Image Restore, click **Cancel**.

8. Select the checkbox to confirm that you want to continue reformatting the hard drive and restoring the system software to the factory condition, then click **Next**.

The restore process begins and may take five or more minutes to complete. A message appears when the operating system and factory-installed applications have been restored to factory condition.

9. Click **Finish** to reboot the system.

Operating System Reinstallation

Before you Begin

If you are considering reinstalling the Windows operating system to correct a problem with a newly installed driver, first try using Windows Device Driver Rollback. If Device Driver Rollback does not resolve the problem, then use System Restore to return your operating system to the operating state it was in before you installed the new device driver. See “System Restore” on page 44.

 **CAUTION:** Before performing the installation, back up all data files on your primary hard drive. For conventional hard drive configurations, the primary hard drive is the first drive detected by the computer.

To reinstall Windows, you need the following:

- Dell *Operating System* disc
- Dell *Drivers and Utilities* disc

Restoring Your Operating System

 **NOTE:** The *Drivers and Utilities* disc contains drivers that were installed during the assembly of the computer. Use the Dell Drivers and Utilities disc to load any required drivers. Depending on the region from which you ordered your computer, or whether you requested the disc, the Dell *Drivers and Utilities* disc and *Operating System* disc may not ship with your computer.

Reinstalling Windows Vista

 **NOTE:** Your computer does not have an internal optical drive. Use an external optical drive or any external storage device for the procedures that involve discs.

The reinstallation process can take 1 to 2 hours to complete. After you reinstall the operating system, you must also reinstall the device drivers, virus protection program, and other software.

1. Save and close any open files and exit any open programs.

2. Insert the *Operating System* disc.
3. Click **Exit** if the **Install Windows** message appears.
4. Restart the computer.
5. When the DELL logo appears, press <F12> immediately.

 **NOTE:** If you wait too long and the operating system logo appears, continue to wait until you see the Microsoft® Windows® desktop; then, shut down your computer and try again.

 **NOTE:** The next steps change the boot sequence for one time only. On the next start-up, the computer boots according to the devices specified in the system setup program.

6. When the boot device list appears, highlight **CD/DVD/CD-RW Drive** and press <Enter>.
7. Press any key to **Boot from CD-ROM**. Follow the instructions on the screen to complete the installation.

Getting Help

If you experience a problem with your computer, you can complete the following steps to diagnose and troubleshoot the problem:

1. See “Solving Problems” on page 31 for information and procedures that pertain to the problem your computer is experiencing.
2. See the *Dell Technology Guide* for more troubleshooting information.
3. See “Dell Diagnostics” on page 41 for procedures on how to run Dell Diagnostics.
4. Fill out the “Diagnostic Checklist” on page 54.
5. Use Dell’s extensive suite of online services available at Dell Support (**support.dell.com**) for help with installation and troubleshooting procedures. See “Online Services” on page 51 for a more extensive list of Dell Support online.
6. If the preceding steps have not resolved the problem, see “Before You Call” on page 54.

 **NOTE:** Call Dell Support from a telephone near or at the computer so that the support staff can assist you with any necessary procedures.

 **NOTE:** Dell’s Express Service Code system may not be available in all countries.

When prompted by Dell’s automated telephone system, enter your Express Service Code to route the call directly to the proper support personnel. If you do not have an Express Service Code, open the **Dell Accessories** folder, double-click the **Express Service Code** icon, and follow the directions.

 **NOTE:** Some of the services are not always available in all locations outside the continental U.S. Call your local Dell representative for information on availability.

Technical Support and Customer Service

Dell's support service is available to answer your questions about Dell hardware. Our support staff use computer-based diagnostics to provide fast, accurate answers.

To contact Dell's support service, see "Before You Call" on page 54 and then see the contact information for your region or go to support.dell.com.

DellConnect™

DellConnect is a simple online access tool that allows a Dell service and support associate to access your computer through a broadband connection, diagnose your problem and repair it all under your supervision. For more information, go to support.dell.com and click **DellConnect**.

Online Services

You can learn about Dell products and services on the following websites:

- **www.dell.com**
- **www.dell.com/ap** (Asian/Pacific countries only)
- **www.dell.com/jp** (Japan only)
- **www.euro.dell.com** (Europe only)
- **www.dell.com/la** (Latin American and Caribbean countries)
- **www.dell.ca** (Canada only)

You can access Dell Support through the following websites and e-mail addresses:

Dell Support websites

- **support.dell.com**
- **support.jp.dell.com** (Japan only)
- **support.euro.dell.com** (Europe only)

Dell Support e-mail addresses

- **mobile_support@us.dell.com**
- **support@us.dell.com**
- **la-techsupport@dell.com** (Latin America and Caribbean countries only)
- **apsupport@dell.com** (Asian/Pacific countries only)

Dell Marketing and Sales e-mail addresses

- **apmarketing@dell.com** (Asian/Pacific countries only)
- **sales_canada@dell.com** (Canada only)

Anonymous file transfer protocol (FTP)

- **ftp.dell.com**

Log in as user: `anonymous`, and use your e-mail address as your password.

Automated Order-Status Service

To check on the status of any Dell products that you have ordered, you can go to **support.dell.com**, or you can call the automated order-status service. A recording prompts you for the information needed to locate and report on your order. For the telephone number to call your region, see “Contacting Dell” on page 55.

If you have a problem with your order, such as missing parts, wrong parts, or incorrect billing, contact Dell for customer assistance. Have your invoice or packing slip handy when you call.

For the telephone number to call for your region, see “Contacting Dell” on page 55

Product Information

If you need information about additional products available from Dell, or if you would like to place an order, visit the Dell website at **www.dell.com**. For the telephone number to call for your region or to speak to a sales specialist, see “Contacting Dell” on page 55.

Returning Items for Repair Under Warranty or for Credit

Prepare all items being returned, whether for repair or credit, as follows:

1. Call Dell to obtain a Return Material Authorization Number, and write it clearly and prominently on the outside of the box.
2. For the telephone number to call for your region, see “Contacting Dell” on page 55.
3. Include a copy of the invoice and a letter describing the reason for the return.
4. Include a copy of the Diagnostics Checklist (see “Diagnostic Checklist” on page 54), indicating the tests that you have run and any error messages reported by the Dell Diagnostics (see “Dell Diagnostics” on page 41).
5. Include any accessories that belong with the item(s) being returned (power cables, software, guides, and so on) if the return is for credit.
6. Pack the equipment to be returned in the original (or equivalent) packing materials.



NOTE: You are responsible for paying shipping expenses. You are also responsible for insuring any product returned, and you assume the risk of loss during shipment to Dell. Collect On Delivery (C.O.D.) packages are not accepted.



NOTE: Returns that are missing any of the preceding requirements will be refused at Dell’s receiving dock and returned to you.

Before You Call

 **NOTE:** Have your Express Service Code ready when you call. The code helps Dell's automated-support telephone system direct your call more efficiently. You may also be asked for your Service Tag (located on the back or bottom of your computer).

Remember to fill out the following Diagnostics Checklist. If possible, turn on your computer before you call Dell for assistance and call from a telephone at or near the computer. You may be asked to type some commands at the keyboard, relay detailed information during operations, or try other troubleshooting steps possible only at the computer itself. Ensure that the computer documentation is available.

Diagnostic Checklist

- Name:
- Date:
- Address:
- Phone number:
- Service Tag (bar code on the back or bottom of the computer):
- Express Service Code:
- Return Material Authorization Number (if provided by Dell support technician):
- Operating system and version:
- Devices:
- Expansion cards:
- Are you connected to a network? Yes/No
- Network, version, and network adapter:
- Programs and versions:

See your operating system documentation to determine the contents of the computer's start-up files. If the computer is connected to

a printer, print each file. Otherwise, record the contents of each file before calling Dell.

- Error message, beep code, or diagnostic code:
- Description of problem and troubleshooting procedures you performed:

Contacting Dell

For customers in the United States, call 800-WWW-DELL (800-999-3355).

 **NOTE:** If you do not have an active Internet connection, you can find contact information on your purchase invoice, packing slip, bill, or Dell product catalog.

Dell provides several online and telephone-based support and service options. Availability varies by country and product, and some services may not be available in your area.

To contact Dell for sales, technical support, or customer service issues:

1. Visit **support.dell.com**.
2. Verify your country or region in the **Choose A Country/Region** drop-down menu at the bottom of the page.
3. Click **Contact Us** on the left side of the page.
4. Select the appropriate service or support link based on your need.
5. Choose the method of contacting Dell that is convenient for you.

Finding More Information and Resources

If you need to:**See:**

reinstall your operating system.

the Operating System disc.

run a diagnostic program for your computer, reinstall notebook system software, or update drivers for your computer, and readme files.

the *Drivers and Utilities* disc.



NOTE: Drivers and documentation updates can be found on the Dell™ Support website at **support.dell.com**.

learn more about your operating system, maintaining peripherals, Internet, Bluetooth®, networking, and e-mail.

the *Dell Technology Guide* installed on your hard drive.

upgrade your computer with new or additional memory, or a new hard drive.

the *Service Manual* on the Dell Support website at **support.dell.com**



NOTE: In some countries, opening and replacing parts of your computer may void your warranty. Check your warranty and return policies before working inside your computer.

reinstall or replace a worn or defective part.

If you need to:

find safety best practices information for your computer

review Warranty information, Terms and Conditions (U.S. only), Safety instructions, Regulatory information, Ergonomics information, and End User License Agreement.

find your Service tag/Express Service Code— You must use the service tag to identify your computer on **support.dell.com** or to contact technical support.

find drivers and downloads.

access technical support and product help.

check on your order status for new purchases.

find solutions and answers to common questions.

locate information for last-minute updates about technical changes to your computer or advanced technical-reference material for technicians or experienced users.

See:

the safety and regulatory documents that shipped with your computer and also see the Regulatory Compliance Homepage at **www.dell.com/regulatory_compliance**.

the back or bottom of your computer.

the Dell Support website at **support.dell.com**.

Specifications

System Model

Studio 14z

This section provides information that you may need when setting up, updating drivers for, and upgrading your computer.



NOTE: Offerings may vary by region.

For more information regarding the configuration of your computer, click

Start  **→ Help and Support** and select the option to view information about your computer.

Processor

<i>Type</i>	<i>L2 cache</i>
Intel® Core™2 Duo	3 MB or 6 MB
Intel Pentium® Dual-Core	1 MB
Intel Celeron® Dual-Core	1 MB
Intel Celeron	1 MB
L1 cache	64 KB (Intel - 32 KB per core)
<i>External bus frequency:</i>	
Intel Core2 Duo	800MHz/1066MHz
Intel Pentium Dual-Core	667MHz
Intel Celeron	667Mhz

Memory

Connectors	one user-accessible SODIMM connector
Capacities	1 GB, 2 GB, and 4 GB
Type	1067 MHz SODIMM DDR3
Minimum	1 GB (single channel)
Maximum	5 GB (dual channel)

 **NOTE:** Memory specification of greater than 4 GB is not well supported by 32-bit operating systems.

Computer Information

System Chipset	Intel NVIDIA MCP79MX
Data bus width	64 bits
DRAM bus width	dual channel (2) 64-bit buses
Processor address bus width	32 bits
Flash EPROM	2 MB

ExpressCard

Controller	Intel MCP79MX
Cards supported	ExpressCard/34 (34 mm) 1.5 V and 3.3 V
Connector size	26 pins

Specifications

Communications

Modem (optional)	External V.92 56K USB modem
Modem controller	Hardware modem
Modem interface	Universal Serial Bus (USB)
Network adapter	10/100/1000 Ethernet LAN on system board
Wireless	WPAN with Bluetooth® wireless technology, internal WWAN, WLAN with WiFi bgn

Video

Video type	integrated on system board
Video controller	NVIDIA GeForce 9400M G

Video

Video memory	256 MB of system memory (shared)
LCD interface	LVDS

Audio

Audio type	IDT 92HD83 High Definition Audio codec
Audio controller	5.1 channel High Definition Audio
Stereo conversion	24-bit (analog-to-digital and digital-to-analog)
Internal Interface	Intel High Definition Audio
Speaker	two 8-ohm speakers and two tweeters
Volume controls	software program menus or keyboard buttons

Connectors

Audio	one microphone connector, two stereo headphone/speaker connectors
IEEE 1394a	4-pin serial connector
Mini-Card	one full Mini-Card and one half Mini-Card slots
Network adapter	RJ45 port
eSATA	one seven-pin/four-pin eSATA/USB combo connector
USB	two 4-pin USB 2.0-compliant connectors
HDMI	19-pin connector
DisplayPort	20-pin connector

Display

Type	14.0 in WLED HD TrueLife and 14.0 in WLED HD+ TrueLife
------	--

Dimensions:

Height	173.95 mm (6.85 inches)
Width	309.4 mm (12.2 inches)
Diagonal	356 mm (14.0 inches)

Maximum resolution:

HD with TrueLife	1366 x 768
HD+ with TrueLife	1600 x 900
Refresh rate	60 Hz
Operating angle	0° (closed) to 140°

Specifications

Display

Viewing Angles:

Horizontal	±40° (HD and HD+ with TrueLife)
Vertical	+15°/–30° (HD and HD+ with TrueLife)

Pixel pitch:

HD with TrueLife	0.2265 mm
HD+ with TrueLife	0.1935 mm
Controls	brightness can be controlled through keyboard shortcuts (see the <i>Dell Technology Guide</i> for more information)

Keyboard (backlit)

Number of keys	86 (U.S. and Canada); 87 (Europe); 90 (Japan); 87 (Brazil)
Layout	QWERTY/AZERTY/Kanji

Camera

Pixel	1.3 megapixel
Video resolution	320 x 240 ~1280 x 1024 (640 x 480 at 30 fps)
Diagonal viewing angle	66°

Touch Pad

X/Y position resolution (graphics table mode)	240 cpi
<i>Size:</i>	
Width	81.0 mm (3.19 inches) sensor-active area
Height	42.0 mm (1.65 inches) rectangle

Battery

Type	6-cell/8-cell smart lithium ion
Depth	48.7 mm (1.92 inches)
Height	20.7 mm (0.81 inches)
Width	273.4 mm (10.8 inches)

Battery

Weight	0.35 kg (0.77 lb) (6-cell) 0.432 kg (0.95 lb) (8-cell)
Voltage	11.1 VDC (6/8-cell)
Charge time (approximate):	4 hours (when the computer is turned off)
Operating time	Battery operating time varies depending on operating conditions and can be significantly reduced under certain power-intensive conditions. See the <i>Dell Technology Guide</i> for more information.
Life span (approximate)	300 discharge/charge cycles

Specifications

Battery

Temperature range:

Operating	0° to 35°C (32° to 95°F)
Storage	-40° to 65°C (-40° to 149°F)
Coin-cell battery	CR-2032

AC Adapter

Input voltage	100–240 VAC 115–230 VAC (Auto-Air Adapter)
Input current (maximum)	1.5 A 2.5 A (Auto-Air Adapter)
Input frequency	50–60 Hz
Output power	65 W

AC Adapter

Output current	4.34 A (maximum at 4-second pulse) 3.34 A (continuous)
----------------	---

Rated output voltage	19.5 +/- 1 VDC
----------------------	----------------

Dimensions:

65 W (E-Series)

Height	16 mm (0.6 inches) 15 mm (0.59 inches) (Auto-Air Adapter)
Width	66 mm (2.6 inches)
Depth	127 mm (5.0 inches)
Weight (with cables)	0.29 kg (0.64 lb) 0.26 kg (0.57 lb) (Auto-Air Adapter, without AC cord and DC extension cord)

Physical

Height	20.0 mm to 30.9 mm (0.787 inches to 1.21 inches)
Width	336.0 mm (13.22 inches)
Depth	229.0 mm (9.01 inches)

Weight (with 6-cell battery):

Configurable to less than	2.13 kg (4.7 lb)
---------------------------	------------------

Relative humidity (maximum):

Operating	10% to 90% (noncondensing)
Storage	5% to 95% (noncondensing)

Physical*Altitude (maximum):*

Operating	-15.2 to 3048 m (-50 to 10,000 ft)
-----------	---------------------------------------

Computer Environment*Temperature range:*

Operating	0° to 35°C (32° to 95°F)
Storage	-40° to 65°C (-40° to 149°F)

Relative humidity (maximum):

Operating	10% to 90% (noncondensing)
Storage	5% to 95% (noncondensing)

Maximum vibration (using a random-vibration spectrum that simulates user environment):

Operating	0.66 GRMS
Storage	1.3 GRMS

Appendix

Macrovision Product Notice

This product incorporates copyright protection technology that is protected by method claims of certain U.S. patents and other intellectual property rights owned by Macrovision Corporation and other rights owners. Use of this copyright protection technology must be authorized by Macrovision Corporation, and is intended for home and other limited viewing uses only unless otherwise authorized by Macrovision Corporation. Reverse engineering or disassembly is prohibited.

Index

A

- AC adapter
 - size and weight **64**
- airflow, allowing **5**

B

- backups
 - creating **30**

C

- calling Dell **54**
- CDs, playing and creating **28**
- chipset **59**
- computer capabilities **28**
- computer, setting up **5**
- conserving energy **29**
- Contacting Dell online **55**

- customer service **50**
- customizing
 - your desktop **29**
 - your energy settings **29**

D

- damage, avoiding **5**
- data, backing up **30**
- DellConnect **50**
- Dell Diagnostics **41**
- Dell Factory Image Restore **44**
- Dell Support Center **38**
- Dell support website **57**
- Dell Technology Guide
 - for further information **56**
- Diagnostic Checklist **54**

Index

DisplayPort connector **19**
drivers and downloads **57**
DVDs, playing and creating **29**

E

email addresses
 for technical support **51**
energy
 conserving **29**
expansion bus **60**

F

finding more information **56**
FTP login, anonymous **51**

H

hardware problems
 diagnosing **41**
Hardware Troubleshooter **41**

help
 getting assistance and support **49**
horizontal and vertical stand options **6**

I

installing the stand **6**
Internet connection **11**
ISP
 Internet Service Provider **11**

M

memory problems
 solving **34**
memory support **59**

N

network connection
 fixing **33**

network speed

testing **32**

P

power problems, solving **33**

power strips, using **6**

problems, solving **31**

processor **58**

products

information and purchasing **52**

R

reinstalling Windows **44**

resources, finding more **56**

restoring factory image **45**

S

setup, before you begin **5**

shipping products

for return or repair **53**

SIM **8**

software features **28**

software problems **35**

solving problems **31**

specifications **58**

support email addresses **51**

support sites

worldwide **50**

System Messages **39**

System Restore **44**

U

USB PowerShare **16**

Index

V

ventilation, ensuring **5**

W

warranty returns **53**

Windows, reinstalling **44**

Windows Vista® **8**

 Program Compatibility Wizard **36**

 reinstalling **48**

wireless network connection **32**



Printed in the U.S.A.

www.dell.com | support.dell.com



OC547MA00